



HD Radio™ Air Interface Design Description Station Information Service Transport

Rev. I

August 23, 2011

TRADEMARKS

HD Radio™ and the HD, HD Radio, and “Arc” logos are proprietary trademarks of iBiquity Digital Corporation.

“iBiquity”, “iBiquity Digital”, and the iBiquity Digital logo are also proprietary trademarks of iBiquity.

All other trademarks, whether claimed or registered, are the exclusive property of their respective owners.

iBiquity Digital Corporation

6711 Columbia Gateway Drive, Suite 500

Columbia, MD 21046

Voice: 443-539-4290

Fax: 443-539-4291

E-mail address:

info@ibiquity.com

Table of Contents

Contents

| | | |
|----------|--|-----------|
| 1 | SCOPE | 1 |
| 1.1 | System Overview | 1 |
| 1.2 | Document Overview | 1 |
| 2 | REFERENCED DOCUMENTS | 2 |
| 3 | ABBREVIATIONS AND CONVENTIONS | 3 |
| 3.1 | Abbreviations and Acronyms | 3 |
| 3.2 | Presentation Conventions | 3 |
| 4 | STATION INFORMATION SERVICE PROTOCOL DATA UNIT FORMAT | 4 |
| 4.1 | Station ID Number (MSG ID = 0000) | 7 |
| 4.2 | Station Name | 9 |
| 4.2.1 | Station Name – short format (MSG ID = 0001) | 9 |
| 4.2.2 | Station Name – long format (MSG ID = 0010) | 10 |
| 4.3 | Absolute Layer 1 Frame Number (MSG ID = 0011) – Discontinued | 11 |
| 4.4 | Station Location (MSG ID 0100) | 12 |
| 4.5 | Station Message (MSG ID 0101) | 13 |
| 4.6 | Service Information Message (MSG ID 0110) | 16 |
| 4.6.1 | Audio Service Descriptors | 16 |
| 4.6.2 | Data Service Descriptors | 19 |
| 4.7 | SIS Parameter Message (MSG ID 0111) | 21 |
| 4.7.1 | Local Time Parameters | 26 |
| 4.7.1.1 | Parameter – Local Time Zone UTC Offset | 26 |
| 4.7.1.2 | Parameter – DST Schedule | 27 |
| 4.7.1.3 | Parameter – DST Local Deployment Indicator | 27 |
| 4.7.1.4 | Parameter – DST Regional Deployment Indicator | 28 |
| 4.7.2 | Broadcast Equipment Software Version Information | 29 |
| 4.8 | Universal Short Station Name / Station Slogan (MSG ID 1000) | 30 |
| 4.8.1 | Universal Short Station Name | 30 |
| 4.8.2 | Station Slogan | 33 |
| 4.9 | Active Radio (AR) Message (MSG ID 1001) | 35 |
| 4.9.1 | AR Message Schedule Requirements | 37 |
| 4.10 | CRC Field | 38 |
| 5 | APPLICATIONS AND EXAMPLES | 39 |
| 5.1 | Station Location Example | 39 |
| 5.2 | Scheduling of SIS PDUs on the PIDS Logical Channel | 39 |
| 5.2.1 | Regular Scheduling | 39 |
| 5.2.2 | Emergency Alert Schedule | 41 |
| 5.3 | Advanced Absolute L1 Frame Number Processing | 42 |
| 5.3.1 | FM System Processing | 42 |
| 5.3.2 | AM System Processing | 43 |
| 5.3.3 | Handling of Absolute L1 Frame Number in Layer 1 | 43 |

| | | |
|-------|----------------------------|----|
| 5.4 | Clock Support..... | 44 |
| 5.4.1 | Handling Leap Seconds..... | 44 |
| 5.4.2 | Handling Local Time | 45 |

List of Figures

| | |
|---|----|
| Figure 4-1: SIS PDU Format – Type = 0 | 4 |
| Figure 4-2: Station ID Number – Message Structure..... | 7 |
| Figure 4-3: Station Name (short format) – Message Structure | 9 |
| Figure 4-4: Station Name (long format) – Message Structure | 10 |
| Figure 4-5: Station Location – Message Structure..... | 12 |
| Figure 4-6: Station Message – Message Structure | 13 |
| Figure 4-7: Checksum Calculation | 15 |
| Figure 4-8: Service Information Message – Message Structure | 16 |
| Figure 4-9: Service Information Message – Message Structure for Audio Service Descriptors..... | 16 |
| Figure 4-10: Service Information Message – Message Structure for Data Service Descriptors | 19 |
| Figure 4-11: SIS Parameter Message – Message Structure | 21 |
| Figure 4-12: Format of SIS Parameter Message Index 0 | 23 |
| Figure 4-13: Format of SIS Parameter Message Index 1 | 23 |
| Figure 4-14: Format of SIS Parameter Message Index 2 | 23 |
| Figure 4-15: Format of SIS Parameter Message Index 3 | 23 |
| Figure 4-16: Format of SIS Parameter Message Index 4 | 24 |
| Figure 4-17: Format of SIS Parameter Message Index 5 | 24 |
| Figure 4-18: Format of SIS Parameter Message Index 6 | 24 |
| Figure 4-19: Format of SIS Parameter Message Index 7 | 24 |
| Figure 4-20: Format of SIS Parameter Message Index 8 | 25 |
| Figure 4-21: Format of SIS Parameter Message Index 9 | 25 |
| Figure 4-22: Format of SIS Parameter Message Index 10 | 25 |
| Figure 4-23: Format of SIS Parameter Message Index 11 | 25 |
| Figure 4-24: General Message Structure for MSG ID 1000 | 30 |
| Figure 4-25: Universal Short Station Name – Message Structure | 31 |
| Figure 4-26: Station Slogan – Message Structure..... | 33 |
| Figure 4-27: Active Radio Message – Message Structure | 35 |
| Figure 5-1: Broadcasting ALFN over the HD Radio FM System..... | 42 |
| Figure 5-2: Broadcasting ALFN over the HD Radio AM System | 43 |

List of Tables

| | |
|--|----|
| Table 4-1: MSG ID Definitions | 5 |
| Table 4-2: Station ID Number – Field Names and Field Descriptions | 7 |
| Table 4-3: Mapping Five-Bit Binary Sequences to Decimal Equivalents and Alpha Characters | 7 |
| Table 4-4: Station Name (short format) – Field Bit Assignments (Positions) | 9 |
| Table 4-5: Station Name (short format) – Character Definitions..... | 9 |
| Table 4-6: Description of Station Message Fields for Frame Number = 0 | 13 |
| Table 4-7: Description of Station Message Fields for Frame Number = 1 to n | 14 |
| Table 4-8: Text Encoding Definitions..... | 14 |
| Table 4-9: Service Category Identifier – Values..... | 16 |
| Table 4-10: Program Number Descriptor | 17 |
| Table 4-11: Audio Service Program Types..... | 17 |
| Table 4-12: Applied Sound Experience Descriptor | 18 |
| Table 4-13: Service Data Type Descriptor..... | 19 |
| Table 4-14: SIS Parameter Message Indices..... | 21 |
| Table 4-15: Local Time Parameters – Bit Positions | 26 |
| Table 4-16: Local Time Zone UTC Offset – U.S. Standard Time Zones | 26 |
| Table 4-17: DST Schedule..... | 27 |
| Table 4-18: Description of Fields within the Common Message Structure for MSG ID 1000..... | 30 |
| Table 4-19: Description of Universal Short Station Name Fields for Frame Number = 0..... | 31 |
| Table 4-20: Description of Universal Short Station Name Fields for Frame Number = 1..... | 32 |
| Table 4-21: Description of Station Slogan Fields for Frame Number = 0 | 33 |
| Table 4-22: Description of Station Slogan Fields for Frame Number = 1 to n..... | 34 |
| Table 4-23: Description of AR Message Fields for Frame Number = 0..... | 35 |
| Table 4-24: Description of Station Message Fields for Frame Number = 1 to n | 36 |
| Table 4-25: Text Encoding Definitions – Active Radio | 36 |
| Table 5-1: Example Scheduling of SIS PDU Messages for the FM System..... | 40 |
| Table 5-2: Example Scheduling of SIS PDU Messages for the AM System..... | 40 |
| Table 5-3: SIS PDU Schedule when AR Message is employed for Emergency Public Alert – FM Schedule | 41 |
| Table 5-4: SIS PDU Schedule when AR Message is employed for Emergency Public Alert – AM Schedule | 41 |

1 Scope

1.1 System Overview

The iBiquity Digital Corporation HD Radio™ system is designed to permit a smooth evolution from current analog amplitude modulation (AM) and frequency modulation (FM) radio to a fully digital in-band on-channel (IBOC) system. This system delivers digital audio and data services to mobile, portable, and fixed receivers from terrestrial transmitters in the existing medium frequency (MF) and very high frequency (VHF) radio bands. Broadcasters may continue to transmit analog AM and FM simultaneously with the new, higher-quality and more robust digital signals, allowing themselves and their listeners to convert from analog to digital radio while maintaining their current frequency allocations.

1.2 Document Overview

This document describes how control and information are passed through the SIS Transport for subsequent processing by Layer 2.

2 Referenced Documents

STATEMENT

Each referenced document that is mentioned in this document shall be listed in the following iBiquity document:

- Reference Documents for the NRSC In-Band/On-Channel Digital Radio Broadcasting Standard
Document Number: SY_REF_2690s

3 Abbreviations and Conventions

3.1 Abbreviations and Acronyms

| | |
|-------|--|
| ADV | Advanced Processing |
| ALFN | Absolute L1 Frame Number |
| AM | Amplitude Modulation |
| ASCII | American Standard Code for Information Interchange |
| CAP | Common Alerting Protocol |
| CRC | Cyclic Redundancy Check |
| DST | Daylight Saving Time |
| EBU | European Broadcasting Union |
| FCC | Federal Communications Commission |
| FEMA | Federal Emergency Management Agency |
| FM | Frequency Modulation |
| GPS | Global Positioning System |
| IBOC | In-Band On-Channel |
| ID | Identification |
| ID3 | Tag Embedded In MPEG I Layer III Files |
| ISO | International Organization for Standardization |
| L1 | Layer 1 |
| LSB | Least Significant Bit |
| MF | Medium Frequency |
| MIME | Multipurpose Internet Mail Extensions |
| MSB | Most Significant Bit |
| MSG | Message |
| PDU | Protocol Data Unit |
| PIDS | Primary IBOC Data Service Logical Channel |
| RBDS | Radio Broadcast Data System |
| SIS | Station Information Service |
| UTC | Coordinated Universal Time |
| VHF | Very High Frequency |
| WGS | World Geodetic System |

3.2 Presentation Conventions

Unless otherwise noted, the following conventions apply to this document:

- All vectors are indexed starting with 0.
- The element of a vector with the lowest index is considered to be first.
- In drawings and tables, the leftmost bit is considered to occur first in time.
- Bit 0 of a byte or word is considered the most significant bit.
- When presenting the dimensions of a matrix, the number of rows is given first (e.g., an $n \times m$ matrix has n rows and m columns).
- In timing diagrams, earliest time is on the left.
- Binary numbers are presented with the most significant bit having the lowest index.
- In representations of binary numbers, the least significant bit is on the right.
- Hexadecimal numbers are represented by a prefix of “0x”

4 Station Information Service Protocol Data Unit Format

The Station Information Service (SIS) provides broadcast station identification and control information. SIS is transmitted in a series of SIS Protocol Data Units (PDUs) on the Primary IBOC Data Service (PIDS) logical channel. For more information on PIDS see [1] and [2]. SIS PDUs are 80 bits in length as shown in Figure 4-1. The most significant bit of each field is shown on the left. Layer 2 and Layer 1 process MSBs first; that is, bit 0 is the first bit interleaved by L1. The PDU contents are defined by several control fields within the PDU. The Type bit is normally set to zero. If this bit is a one, the remainder of the PDU contents may be different. This option is reserved for future use.

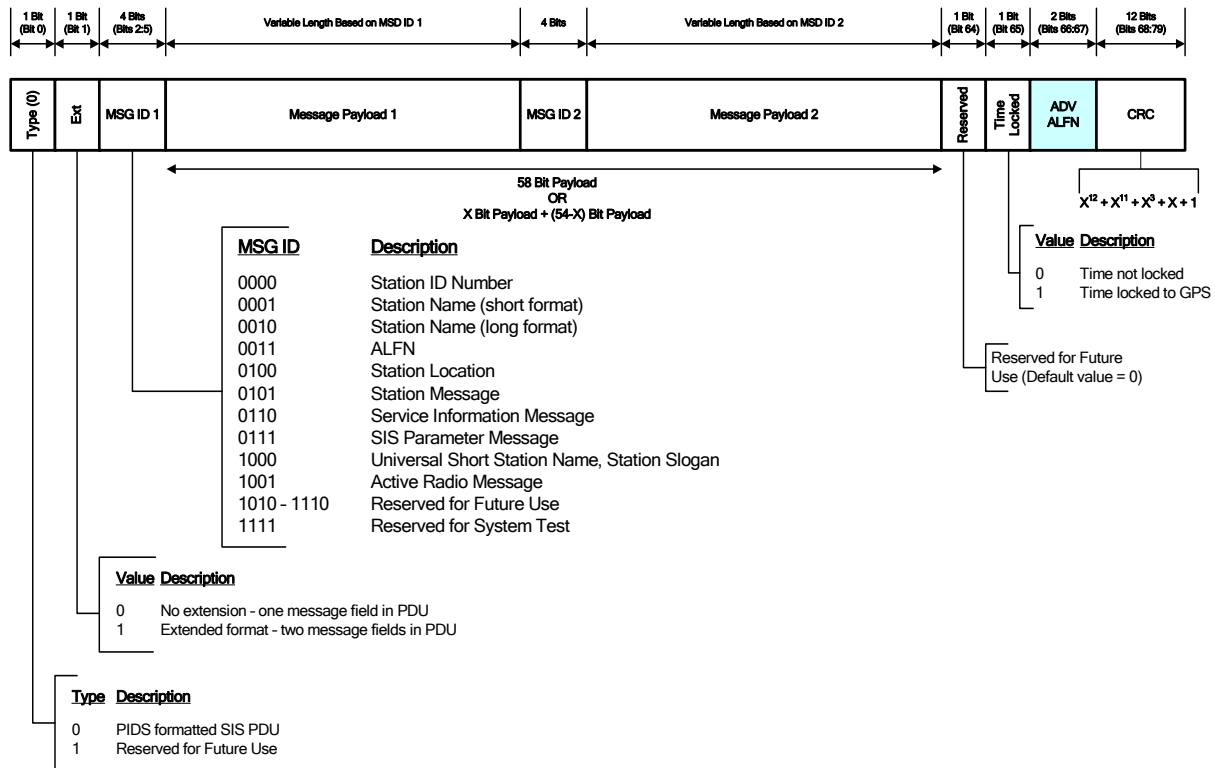

NOTES

MSG ID [0010] Station Name (long format): Not recommended for new designs

MSG ID [0011] ALFN: Discontinued; MSG ID [0011] is not needed since ALFN is already sent serially in the “ADV ALFN” field in the SIS PDU

Figure 4-1: SIS PDU Format – Type = 0

Type 0 PDUs may contain two, independent, variable-length, short message fields or a single longer message, depending on the state of the Ext bit. If the Ext bit equals 0, the message payload 1 field is up to 58 bits in length and the message contents are determined by the state of the first message ID 1 field, Any unused bits at the end of the message payload 1 field are set to zero. If the Ext bit equals 1, then the first message payload and contents are defined by MSG ID 1, and a second message may be present, with payload length and contents defined by MSG ID 2. In this case, the combined payload lengths of the two messages must be no greater than 54 bits. Any unused bits at the end of message payload 2 are set to zero.

The definitions of the MSG ID 1 and MSG ID 2 fields are identical. Refer to Table 4-1 for details of the MSG ID field. Any message may be placed in either message 1 or message 2 provided that the total 56-bit available payload length is not violated. Longer messages must use the single message option (Ext = 0).

Table 4-1: MSG ID Definitions

| MSG ID | Payload (bits) | Description | Comments |
|--------|----------------|--|---|
| 0000 | 32 | Station ID Number | Used for networking applications Consists of Country Code and FCC Facility ID. |
| 0001 | 22 | Station Name – short format | Identifies the 4-alpha-character station call sign plus an optional extension |
| 0010 | 58 | Station Name – long format | Identifies the station call sign or other identifying information in the long format May consist of up to 56 alphanumeric characters Not recommended for new designs |
| 0011 | 32 | ALFN | Identifies the current Absolute Layer 1 Frame Number (ALFN) Discontinued MSG ID [0011] is not needed since ALFN is already sent serially in the “ADV ALFN” field in the SIS PDU as shown in Figure 4-1. |
| 0100 | 27 | Station Location | Provides the 3-dimensional geographic station location Used for receiver position determination |
| 0101 | 58 | Station Message | Allows a station to send an arbitrary text message |
| 0110 | 27 | Service Information Message | Identifies Program category of the Main and Supplemental programs. Introduces the data services |
| 0111 | 22 | SIS Parameter Message | Carries supplementary information, including Leap Second/Time Offset and Local Time data parameters |
| 1000 | 58 | Universal Short Station Name Station Slogan | Allows transmitting the station names up to twelve characters in length and supports international character sets |
| 1001 | 58 | Active Radio (AR) Message | Allows for the provision of Emergency Alerts and follow-up information Allows for the “waking up” of a receiver |

| MSG ID | Payload (bits) | Description | Comments |
|-------------|----------------|-------------|-------------------------|
| 1010 - 1110 | TBD | Reserved | Reserved for future use |
| 1111 | TBD | Reserved | Reserved |

The following subsections describe each message type (MSG ID).

4.1 Station ID Number (MSG ID = 0000)

This message type is uniquely assigned to each broadcasting facility. Figure 4-2 shows the message structure for the Station ID Number.

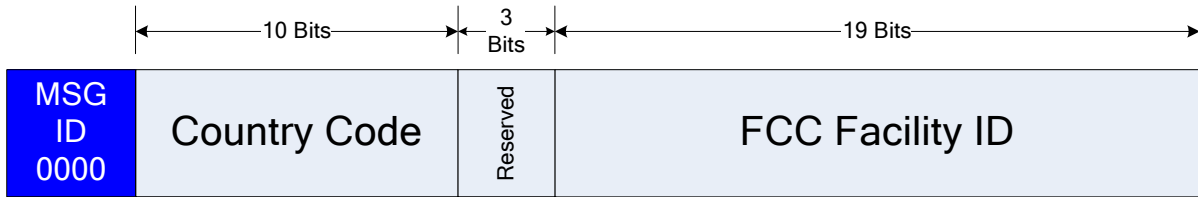

Figure 4-2: Station ID Number – Message Structure

Table 4-2 lists and describes the fields in the Station ID Number.

Table 4-2: Station ID Number – Field Names and Field Descriptions

| Field Name | Number of Bits | Field Description |
|-----------------------------|----------------|---|
| Country Code | 10 | In binary representation, the ten bits shall be used to represent the two-character country code as specified in Reference [14] |
| Reserved | 3 | Reserved bits default to “0” |
| FCC Facility ID (U.S. only) | 19 | Binary representation of unique facility ID assigned by the FCC in the U.S. Reference: [17] |

With regard to the Country Code, the ISO 3166-1-alpha-2 code elements are two-letter codes. At the time of this publication, there were 246 code elements (that is, 246 countries) represented.

Table 4-3 maps each five bit binary sequence to its decimal equivalent and its alpha character.

Table 4-3: Mapping Five-Bit Binary Sequences to Decimal Equivalents and Alpha Characters

| Five-Bit Binary Sequence | Decimal Equivalent | Alpha Character |
|--------------------------|--------------------|-----------------|
| 00000 | 0 | A |
| 00001 | 1 | B |
| 00010 | 2 | C |
| 00011 | 3 | D |
| 00100 | 4 | E |
| 00101 | 5 | F |
| 00110 | 6 | G |
| 00111 | 7 | H |
| 01000 | 8 | I |
| 01001 | 9 | J |
| 01010 | 10 | K |
| 01011 | 11 | L |
| 01100 | 12 | M |
| 01101 | 13 | N |
| 01110 | 14 | O |
| 01111 | 15 | P |
| 10000 | 16 | Q |
| 10001 | 17 | R |

| Five-Bit Binary Sequence | Decimal Equivalent | Alpha Character |
|--------------------------|--------------------|-----------------|
| 10010 | 18 | S |
| 10011 | 19 | T |
| 10100 | 20 | U |
| 10101 | 21 | V |
| 10110 | 22 | W |
| 10111 | 23 | X |
| 11000 | 24 | Y |
| 11001 | 25 | Z |

Note that the alpha characters are capital letters from the English alphabet.

As an example, using the details from Table 4-3, for the United States (US), the individual-letter decimal equivalents for the US would be 20 (U) and 18 (S); the individual-letter binary equivalents for the US would be 10100 (U) and 10010 (S).

To form a country code, these two five-bit binary numbers are concatenated to form a single 10-bit binary number. The left-most character is contained in the most significant bits. In binary, the country code (US) would be 1010010010 and in decimal, the country code (US) would be 658.

Other country code examples include Canada (CA) which would be 0001000000 in binary and 64 in decimal; Brazil (BR) would be 0000110001 in binary and 49 in decimal.

4.2 Station Name

This message type has both a short format and a long format. The short format may be used with the two-message PDU structure so that it may be multiplexed with other messages and thus can be repeated frequently. The long format requires the single-message structure and may be extended across multiple PDUs. This format can be used to identify stations by a moderately long text string.

4.2.1 Station Name – short format (MSG ID = 0001)

Four-character station names may be broadcast with the short format. The field is 22 bits in length with the first bit on the left. Figure 4-3 shows the message structure for the Station Name (short format).

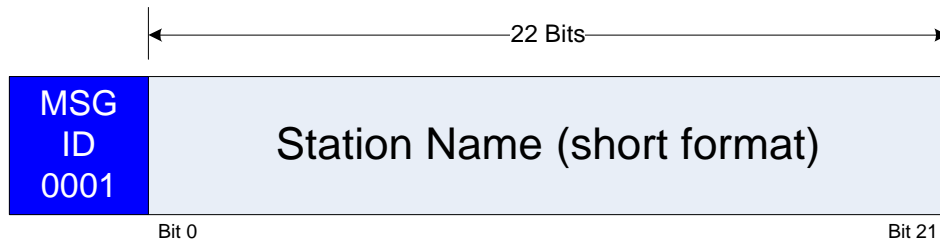

Figure 4-3: Station Name (short format) – Message Structure

Each character is five bits in length (MSB first, or leftmost), followed by a 2-bit extension. Refer to Table 4-4 for details of the field bit assignments (positions) and Table 4-5 for the character definitions. Only upper-case characters are defined, plus a limited number of special characters, as shown. The space character may be used, for example, to terminate a three-character call sign.

The first five bits are assumed to contain the leftmost character. For example, a station name of “ABCD” would be encoded in binary as 00000 00001 00010 00011 00. The 2-bit extension may be used to append an extension to the right of the other four characters (00 in the preceding example).

Table 4-4: Station Name (short format) – Field Bit Assignments (Positions)

| Field Bit Positions | Description |
|---------------------|---|
| 0:4 | Leftmost Character |
| 5:9 | Second Leftmost Character |
| 10:14 | Third Leftmost Character |
| 15:19 | Rightmost Character |
| 20:21 | Extensions: 00 = no extension 01 = Append “-FM” 10 = Reserved for future use 11 = Reserved for future use |

Table 4-5: Station Name (short format) – Character Definitions

| Value (MSB:LSB) | Character |
|---------------------------------|-------------------------------|
| 00000, 00001, 00010, ..., 11001 | A, B, C, ..., Z See Table 4-3 |
| 11010 | space character |
| 11011 | ? |
| 11100 | - |
| 11101 | * |
| 11110 | \$ |

| | |
|-------|----------|
| 11111 | Reserved |
|-------|----------|

4.2.2 Station Name – long format (MSG ID = 0010)

The long format permits the station name to consist of textual strings. Each message contains seven characters encoded as 7-bit ISO-8859-1 characters [22]. In other words, it uses the first 128 characters of the ISO-8859-1 character set and the most significant bit of the 8-bit character code is truncated to form a 7-bit character.

The Station Name (long format) accommodates up to 56 characters in the name.

A character string may be extended over up to eight PDUs. The first three bits of the field specify the frame number of the last frame (or equivalently, the total number of SIS PDUs containing the message minus one) and the next three bits specify the frame number of the current PDU. PDU number zero is considered the leftmost of the string. The seven most significant station name bits within a PDU define the leftmost character for that PDU. For the last SIS PDU of the string, unused message bits are filled in with null characters (0x00).

The three LSBs of the Station Name message structure define the sequence number. This number is incremented modulo eight each time the character string is changed. The sequence number will only change within the PDU containing frame 0 of the message. All frames of the same message content will always have the same sequence number.

Figure 4-4 illustrates the message structure for Station Name (long format).

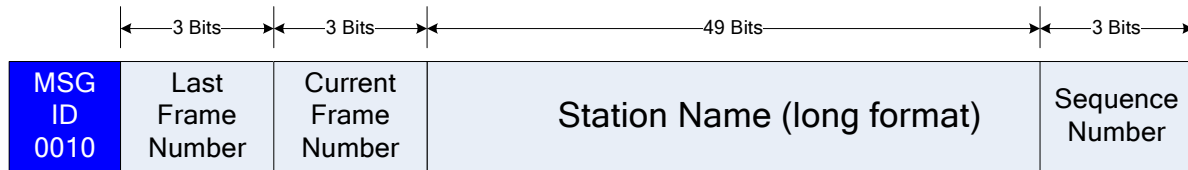

Figure 4-4: Station Name (long format) – Message Structure

As indicated in Figure 4-1 and Table 4-1, Station Name – long format (MSG ID = 0010) is not recommended for new designs.

4.3 Absolute Layer 1 Frame Number (MSG ID = 0011) – Discontinued

4.4 Station Location (MSG ID 0100)

This message type indicates the absolute three-dimensional location of the feedpoint of the broadcast antenna. Such location information may be used by the receiver for position determination. The message structure is shown in Figure 4-5. Position information is split into two messages: a high portion and a low portion.

Altitude is in units of [meters·16] (that is, the LSB is equal to 16 meters). Latitude and longitude are both in the same fractional formats. The LSB is equal to 1/8192 degrees. The MSB is the sign bit, which indicates the hemisphere. Positive longitude values represent positions north of the equator. Positive latitudes are in the eastern hemisphere. Longitude ranges are from -180 to +180, while permissible latitude values are between -90 and +90. Anything outside of these ranges is invalid. Refer to Subsection 5.1 for an example.

Used by the Global Positioning System, the World Geodetic System 84 (WGS 84) is used as the reference datum for location information. See Reference [18].

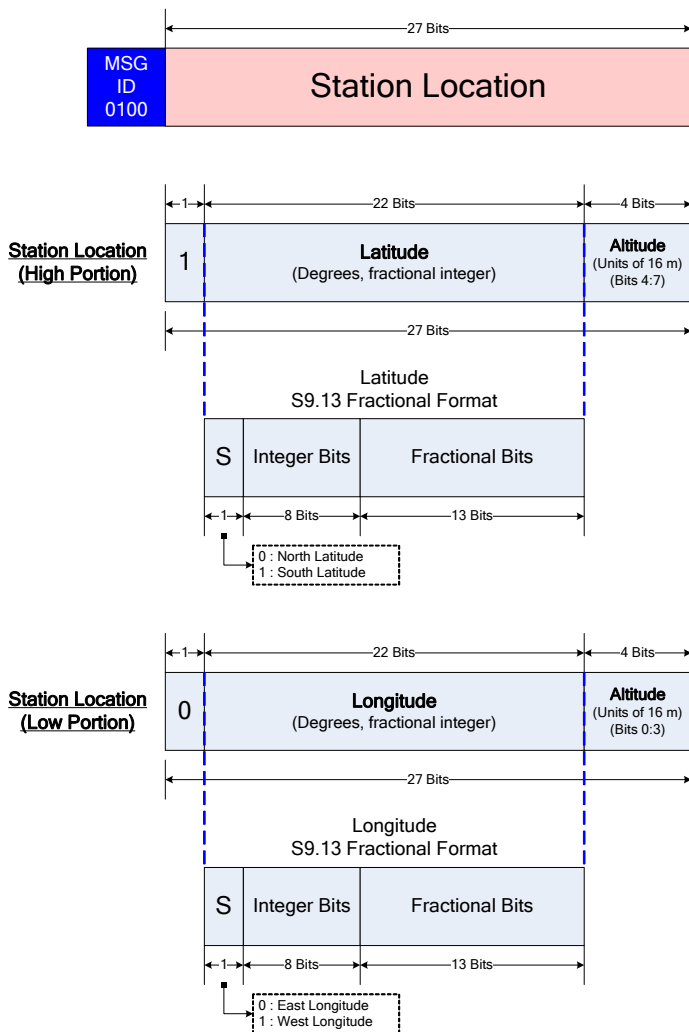

Figure 4-5: Station Location – Message Structure

4.5 Station Message (MSG ID 0101)

This message type allows the station to send any arbitrary text message. Examples include public service announcements, weather reports, or telephone call-in numbers. The Station Message has a total payload of 58 bits per frame. This message can span over multiple frames. Figure 4-6 shows the message structure for the Station Message. The format of the first frame is different from the others, as shown.

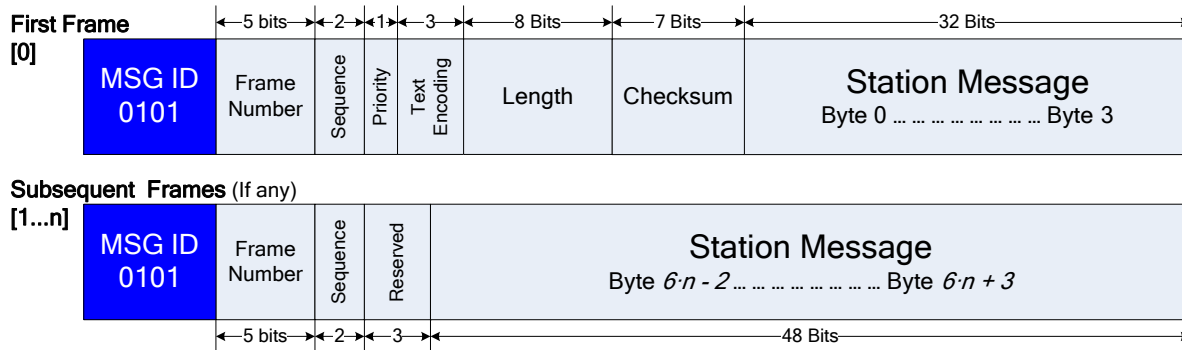

Figure 4-6: Station Message – Message Structure

The Station Message can be used to send a string of up to 190 8-bit characters [22] or 95 16-bit characters [23] per message. A message may span up to 32 frames. Each message contains a sequence number, indicating when the message text or priority has changed. A priority indicator is included to indicate that a message has an elevated importance. When multiple messages are broadcast, a message with the priority indicator set will advance to the top of the receiver queue. Any change in the message content or the priority is considered a new message and the sequence number is incremented. A 7-bit checksum is included in the first frame to increase receive reliability.

Table 4-6 and Table 4-7 describe the data fields for the first and subsequent frames, respectively.

Table 4-6: Description of Station Message Fields for Frame Number = 0

| Field Name | Range | Description |
|---------------|---------|--|
| Frame Number | 0 | Indicates the current frame number of the message Set to zero for the first frame |
| Sequence | 0 - 3 | Increments by 1, modulo 4, whenever the station message text and/or priority changes A new sequence number must commence with frame 0 and the same number shall be used for all frames of a given Station Message |
| Priority | 0 - 1 | Priority = 0: Normal priority Priority = 1: High priority When multiple Station Messages are broadcast, the receiver shall place a high priority message at the top of the queue as soon as it is received |
| Text Encoding | 0 - 7 | See Table 4-8 |
| Length | 4 - 190 | Defines the total number of bytes of the Station Message text, excluding any unused bytes in the last frame For 16-bit character encoding, the Length must be even |
| Checksum | 0 - 127 | Checksum of all the data bytes of the Station Message text, excluding overhead bytes Refer to Figure 4-7 for details |

| Field Name | Range | Description |
|-----------------|-------|---|
| Station Message | N/A | <p>For 8-bit character encoding, frame 0 contains the first 4 characters of the Station Message Byte 0 is the leftmost character For single-frame Station Messages, any unused bytes to the right of the Station Message text are filled with NULL characters (0x00)</p> <p>For 16-bit character encoding, frame 0 contains the first 2 characters of the Station Message Bytes 0:1 convey the leftmost character For single-frame Station Messages, any unused byte pairs to the right of the Station Message text are filled with NULL characters (0x00 00)</p> |

Table 4-7: Description of Station Message Fields for Frame Number = 1 to n

| Field Name | Range | Description |
|-----------------|--------|---|
| Frame Number | 1 - 31 | Indicates the current frame number of the message |
| Sequence | 0 - 3 | <p>Increments by 1, modulo 4, whenever the station message text and/or priority changes A new sequence number must commence with frame 0 and the same number shall be used for all frames of a given Station Message</p> |
| Reserved | 0 - 7 | Reserved for future use |
| Station Message | N/A | <p>For 8-bit character encoding, frames 1 to n contain the additional characters of the Station Message, where the lowest numbered byte within a frame is the leftmost for that frame For the last frame, any unused bytes to the right of the Station Message text are filled with NULL characters (0x00)</p> <p>For 16-bit character encoding, frames 1 to n contain additional characters of the Station Message, where the lowest numbered byte-pair within a frame is the leftmost for that frame For the last frame, any unused byte pairs to the right of the Station Message text are filled with NULL characters (0x00 00)</p> |

NRSC Supplemental Information provides the most up-to-date information regarding the Text Encoding Definitions: http://www.ibiquity.com/broadcasters/us_regulatory/nrsc_supplemental_information.

Table 4-8: Text Encoding Definitions

| Value | Service Type |
|---------------|---|
| 000 (default) | ISO/IEC 8859-1:1998 (Reference [22]) |
| 001 to 011 | Reserved |
| 100 | ISO/IEC 10646-1:2000 UCS-2 (Little Endian) (Reference [23]) |
| 101 to 111 | Reserved |

Figure 4-7 illustrates the method used to calculate the 7-bit checksum. First, a 16-bit sum is computed by adding together all of the bytes of the station message text bytes (excluding overhead). The message bytes and the sum are both treated as unsigned integers. The 16-bit sum is then divided into a high (most significant) byte and a low (least significant) byte. The most significant bit of the high byte (bit 15 in Figure 4-7) is cleared. The high and low bytes are then summed together and the seven least significant bits of the sum are written into the checksum field, where the most significant bit is the left-most checksum bit shown in Figure 4-6.

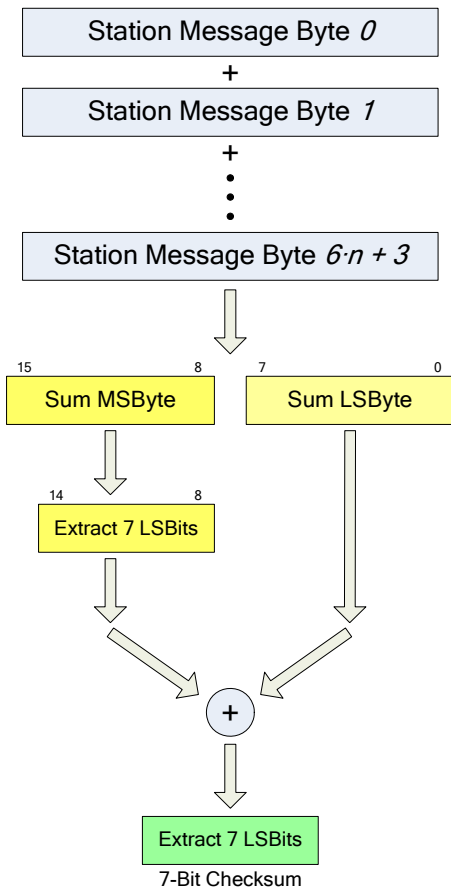

Figure 4-7: Checksum Calculation

4.6 Service Information Message (MSG ID 0110)

This message type is used to indicate the available audio and data services independently. It allows for future expansion of the number of audio programs and types. It provides an indication of multi-channel audio features. It also indicates features for available data services. This allows the receiver to enable or disable the desired services.

Figure 4-8 shows the message structure for the Service Information Message. The message consists of 27 bits which include a Service Category identifier and Service Descriptors. These bits aid the receiver in faster searching/scanning for available and/or desired programs.

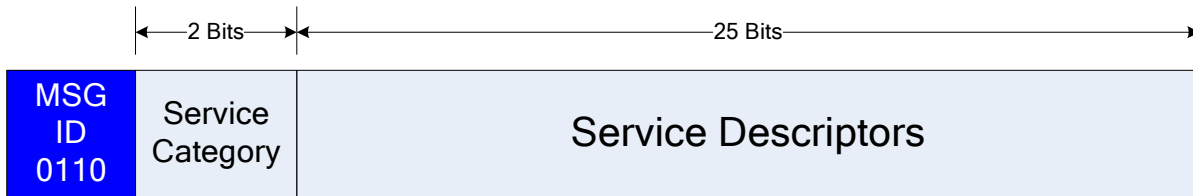

Figure 4-8: Service Information Message – Message Structure

The values for the Service Category identifier are shown in Table 4-9.

Table 4-9: Service Category Identifier – Values

| Service Category Identifier Value | Service Category Identifier Description |
|-----------------------------------|---|
| 00 | Audio |
| 01 | Data |
| 10 - 11 | Reserved |

The Service Descriptors for the audio and the data service categories are described in the following subsections.

4.6.1 Audio Service Descriptors

Figure 4-9 shows the Service Information Message structure containing descriptors for an audio program.

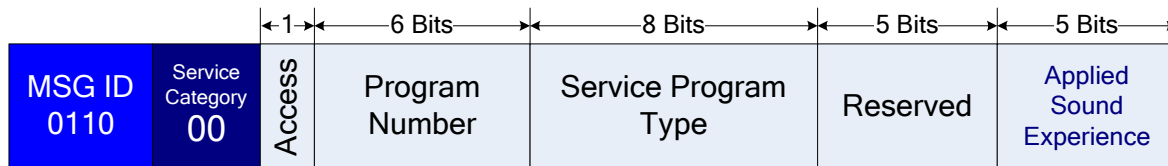

Figure 4-9: Service Information Message – Message Structure for Audio Service Descriptors

The audio service category is indicated by a service category identifier value of “00” in the Service Information Message.

The service descriptor portion contains information about Access, Program Number, Service Program Type, and Applied Sound Experience.

For the 1-bit Access descriptor, 0 indicates “public/unrestricted” and 1 indicates “restricted”.

The Program Number descriptor is used to identify and manage the MPS or SPS programs transmitted as shown in Table 4-10.

Table 4-10: Program Number Descriptor

| Program Number | Description |
|----------------|-------------|
| 0 | MPS |
| 1 - 7 | SPS |
| 8 - 63 | Reserved |

The Audio Service Program Types enable a receiver to search and sort through the variety of program content being broadcast. The Audio Service Program Types defined for use in the HD Radio system are described in NRSC-4 [29] and are shown in Table 4-11. Audio Service Program Type numbers zero through 31 comply with the RBDS specification (NRSC-4).

NRSC Supplemental Information provides the most up-to-date information regarding the Audio Service Program Types: http://www.ibiquity.com/broadcasters/us_regulatory/nrsc_supplemental_information.

Table 4-11: Audio Service Program Types

| Audio Service Program Type Number | Audio Service Program Type Description |
|-----------------------------------|--|
| 0 | See the RBDS Standard, NRSC-4 |
| 1 | See the RBDS Standard, NRSC-4 |
| 2 | See the RBDS Standard, NRSC-4 |
| 3 | See the RBDS Standard, NRSC-4 |
| 4 | See the RBDS Standard, NRSC-4 |
| 5 | See the RBDS Standard, NRSC-4 |
| 6 | See the RBDS Standard, NRSC-4 |
| 7 | See the RBDS Standard, NRSC-4 |
| 8 | See the RBDS Standard, NRSC-4 |
| 9 | See the RBDS Standard, NRSC-4 |
| 10 | See the RBDS Standard, NRSC-4 |
| 11 | See the RBDS Standard, NRSC-4 |
| 12 | See the RBDS Standard, NRSC-4 |
| 13 | See the RBDS Standard, NRSC-4 |
| 14 | See the RBDS Standard, NRSC-4 |
| 15 | See the RBDS Standard, NRSC-4 |
| 16 | See the RBDS Standard, NRSC-4 |
| 17 | See the RBDS Standard, NRSC-4 |
| 18 | See the RBDS Standard, NRSC-4 |
| 19 | See the RBDS Standard, NRSC-4 |
| 20 | See the RBDS Standard, NRSC-4 |
| 21 | See the RBDS Standard, NRSC-4 |
| 22 | See the RBDS Standard, NRSC-4 |
| 23 | See the RBDS Standard, NRSC-4 |
| 24 | See the RBDS Standard, NRSC-4 |
| 25 | See the RBDS Standard, NRSC-4 |
| 26 | See the RBDS Standard, NRSC-4 |
| 27 | See the RBDS Standard, NRSC-4 |
| 28 | See the RBDS Standard, NRSC-4 |
| 29 | See the RBDS Standard, NRSC-4 |
| 30 | See the RBDS Standard, NRSC-4 |

| Audio Service Program Type Number | Audio Service Program Type Description |
|-----------------------------------|--|
| 31 | See the RBDS Standard, NRSC-4 |
| 32 to 64 | Reserved |
| 65 | Traffic |
| 66 to 75 | Reserved |
| 76 | Special Reading Services |
| 77 to 255 | Reserved |

The bits in the Reserved descriptor default to “0”.

The Applied Sound Experience descriptor is used to indicate the type of sound and audio processing used. The various sound and audio processing methods used and their corresponding values in the Applied Sound Experience descriptor are shown in Table 4-12.

NRSC Supplemental Information provides the most up-to-date information regarding the Applied Sound Experience Types: http://www.ibequity.com/broadcasters/us_regulatory/nrsc_supplemental_information.

Table 4-12: Applied Sound Experience Descriptor

| Applied Sound Experience Value | Applied Sound Experience Method |
|--------------------------------|---------------------------------|
| 0 | None |
| 1 | SRS Circle Surround |
| 2 | Dolby ProLogic2 Surround |
| 3 | Neural Surround |
| 4 | FHG HEMP3 Surround |
| 5 | DTS Matrix Surround |
| 6 | CT Surround |
| 7 to 31 | Reserved |

4.6.2 Data Service Descriptors

Figure 4-10 shows the Service Information Message structure containing descriptors for a data service.

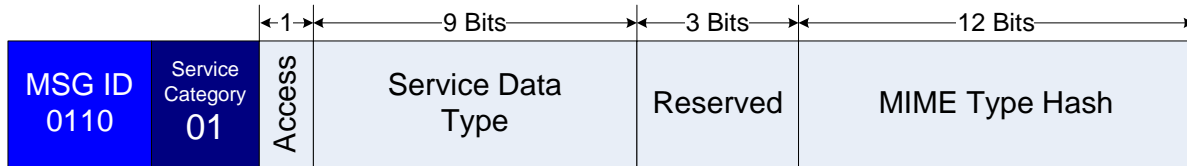

Figure 4-10: Service Information Message – Message Structure for Data Service Descriptors

The data service category is indicated by a service category identifier value of “01” in the Service Information Message.

The service descriptor portion contains information about Access, Service Data Type, and MIME Type Hash (only 12 least significant bits).

For the 1-bit Access descriptor, 0 indicates “public/unrestricted” and 1 indicates “restricted”.

The Service Data Type descriptor is defined in Table 4-13.

NRSC Supplemental Information provides the most up-to-date information regarding the Service Data Types: http://www.ibequity.com/broadcasters/us_regulatory/nrsc_supplemental_information.

Table 4-13: Service Data Type Descriptor

| Service Data Type Number | Service Data Type Definition |
|--------------------------|--------------------------------|
| 0 | Non-specific |
| 1 | News |
| 2 | Reserved |
| 3 | Sports |
| 4 to 28 | Reserved |
| 29 | Weather |
| 30 | Reserved |
| 31 | Emergency |
| 32 to 64 | Reserved |
| 65 | Traffic |
| 66 | Image Maps |
| 67 to 79 | Reserved |
| 80 | Text |
| 81 to 255 | Reserved |
| 256 | Advertising |
| 257 | Financial |
| 258 | Stock Ticker |
| 259 | Navigation |
| 260 | Electronic Program Guide (EPG) |
| 261 | Audio |
| 262 | Private Data Network |
| 263 | Service Maintenance |
| 264 | HD Radio System Services |
| 265 | Audio-Related Objects |

| Service Data Type Number | Service Data Type Definition |
|---------------------------------|-------------------------------------|
| 266 to 510 | Reserved |
| 511 | Reserved for Special Tests |

The MIME Type Hash descriptor is used to indicate the type of Application MIME Type used.

4.7 SIS Parameter Message (MSG ID 0111)

This message type is used to carry various system parameters. The SIS Parameter Message has a payload of 22 bits which consists of a 6-bit index field and a 16-bit parameter field.

Figure 4-11 shows the message structure for the SIS Parameter Message.



Figure 4-11: SIS Parameter Message – Message Structure

The SIS Parameter Message indices are defined in Table 4-14.

Table 4-14: SIS Parameter Message Indices

| Index | Description | Comments | Reference Figure |
|-------|--|--|------------------|
| 0 | Leap Second Offset Most significant byte: Pending Offset (8-bit signed) Least significant byte: Current Offset (8-bit signed) Refer to Subsection 5.4 for details on the application of the Leap Second | Reference [21] If this information is unavailable, it is recommended that a default value of 0x0F0F be used which is current as of the date of this document. | Figure 4-12 |
| 1 | ALFN representing the GPS time of a pending leap second adjustment (16 LSBs) | Set to 0 if a leap second is not pending | Figure 4-13 |
| 2 | ALFN representing the GPS time of a pending leap second adjustment (16 MSBs) | Set to 0 if a leap second is not pending | Figure 4-14 |
| 3 | Local Time Data (Refer to Subsection 4.7.1) Refer to Subsection 5.4 for details on the application of the Local Time parameters. | | Figure 4-15 |
| 4 | Exciter Manufacturer ID / ICB (Importer Connected Bit) | Two 7-bit characters ISO/IEC 8859-1 Format Valid Values: 32 to 126 | Figure 4-16 |
| 5 | Exciter Core Version Number Levels 1 through 3 | Level 1: Left-most (most significant level) Level 3: Right-most (least significant level) Valid Range: 0 to 30 31: Invalid / not used | Figure 4-17 |

| Index | Description | Comments | Reference Figure |
|----------|---|---|------------------|
| 6 | Exciter Manufacturer-assigned Version Number Levels 1 through 3 | Level 1: Left-most (most significant level) Level 3: Right-most (least significant level) Valid Range: 0 to 30 31: Invalid / not used | Figure 4-18 |
| 7 | Exciter Core Version Number 4 and Status / Exciter Manufacturer-assigned Version Number 4 and Status | Level 4 Version Number Valid Range: 0 to 30 31: Invalid / Not Used Status 0: Commercial Release 1: Engineering Release 2: Patch 3 to 7: Reserved | Figure 4-19 |
| 8 | Importer Manufacturer ID | Two characters ISO/IEC 8859-1 Format Valid Values: 32 to 126 | Figure 4-20 |
| 9 | Importer Core Version Number Levels 1 through 3 | Level 1: Left-most (most significant level) Level 3: Right-most (least significant level) Valid Range: 0 to 30 31: Invalid / not used | Figure 4-21 |
| 10 | Importer Manufacturer-assigned Version Number Levels 1 through 3 | Level 1: Left-most (most significant level) Level 3: Right-most (least significant level) Valid Range: 0 to 30 31: Invalid / not used | Figure 4-22 |
| 11 | Importer Core Version Number 4 and Status / Importer Manufacturer-assigned Version Number 4 and Status | Level 4 Version Number Valid Range: 0 to 30 31: Invalid / Not Used Status 0: Commercial Release 1: Engineering Release 2: Patch 3 to 7: Reserved | Figure 4-23 |
| 12 to 63 | Reserved for future use. | — | — |

For each of the individual fields shown in Figure 4-12 through Figure 4-23, the most significant bit is on the left.

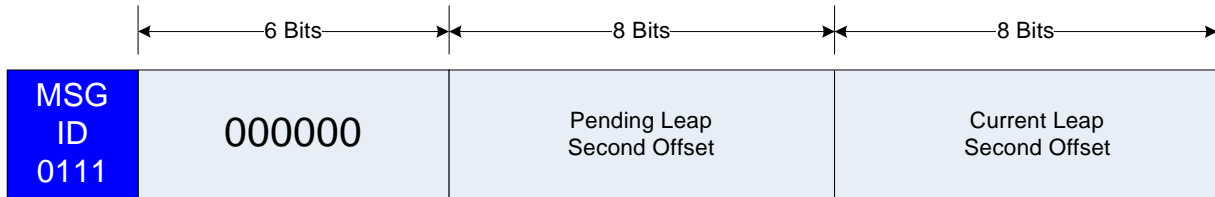

Figure 4-12: Format of SIS Parameter Message Index 0

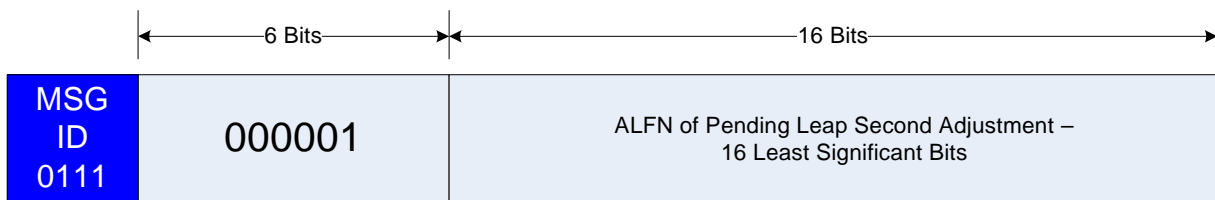

Figure 4-13: Format of SIS Parameter Message Index 1

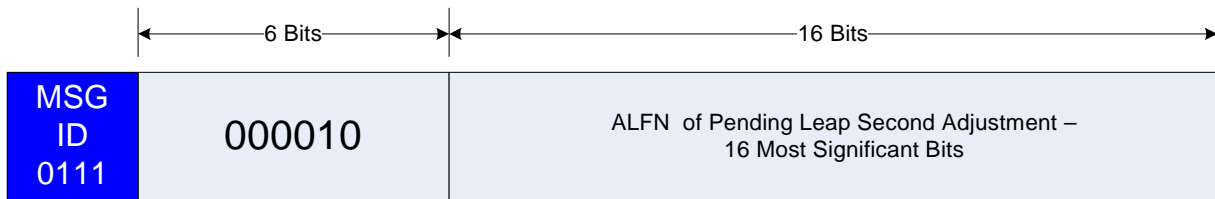

Figure 4-14: Format of SIS Parameter Message Index 2



Figure 4-15: Format of SIS Parameter Message Index 3

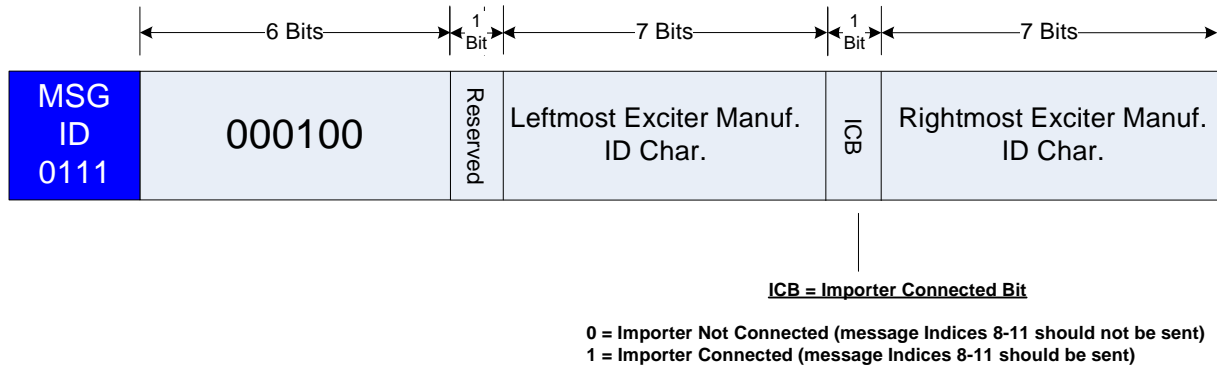

Figure 4-16: Format of SIS Parameter Message Index 4

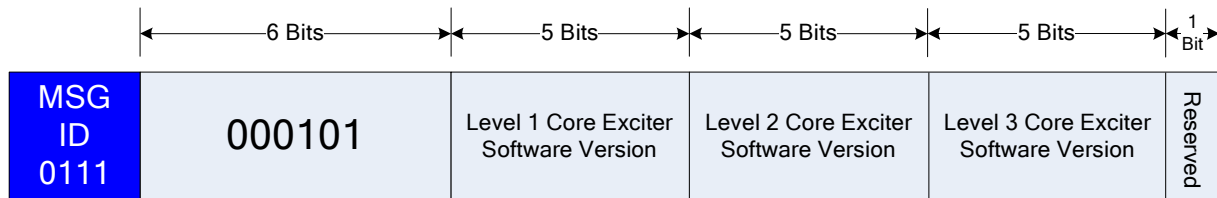

Figure 4-17: Format of SIS Parameter Message Index 5

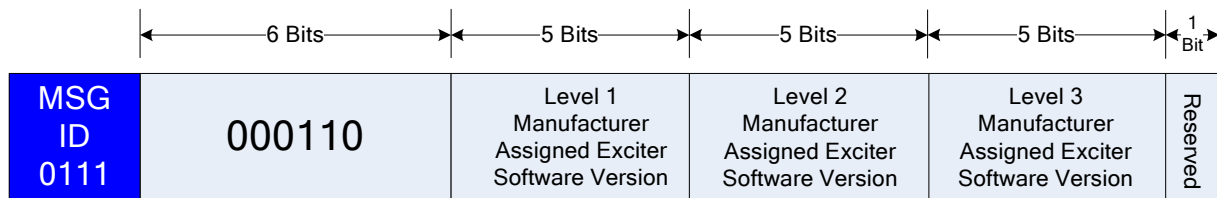

Figure 4-18: Format of SIS Parameter Message Index 6

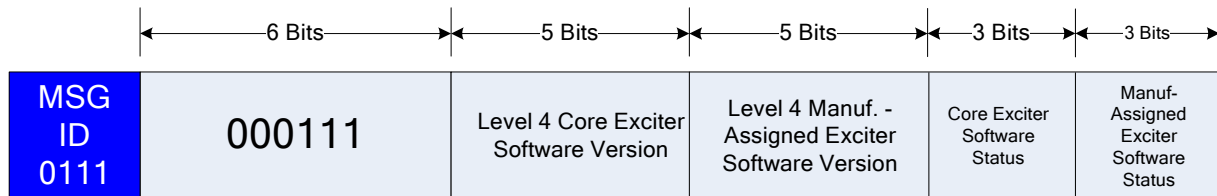

Figure 4-19: Format of SIS Parameter Message Index 7

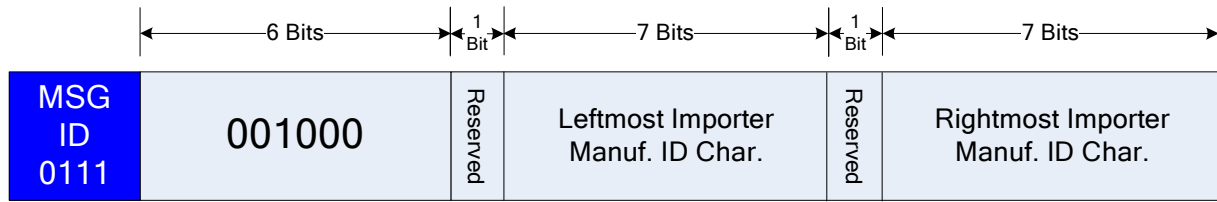

Figure 4-20: Format of SIS Parameter Message Index 8

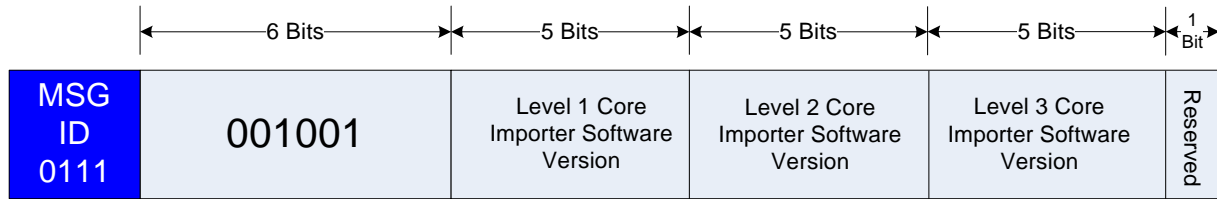

Figure 4-21: Format of SIS Parameter Message Index 9

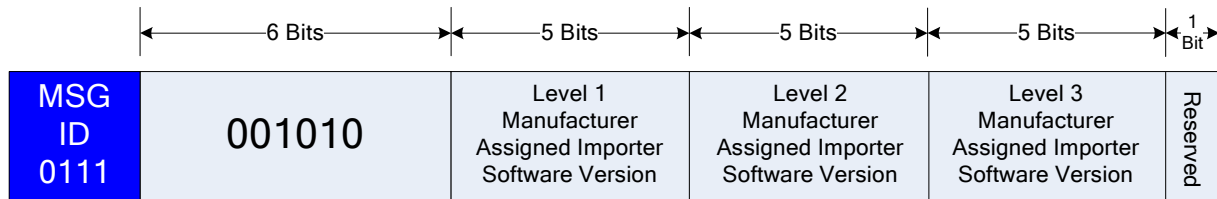

Figure 4-22: Format of SIS Parameter Message Index 10

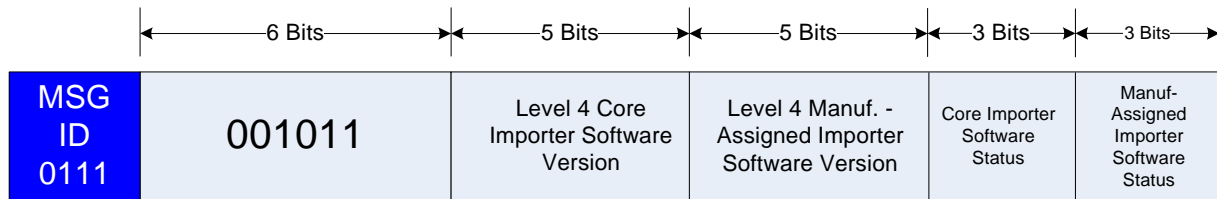

Figure 4-23: Format of SIS Parameter Message Index 11

The following subsections define the SIS Parameter Messages.

4.7.1 Local Time Parameters

The bit positions for the various Local Time parameters are summarized in Table 4-15.

Table 4-15: Local Time Parameters – Bit Positions

| Bits | Parameter | Units | Format |
|-------|--|---------|----------------|
| 0:10 | Local Time Zone UTC Offset (See Subsection 4.7.1.1) | Minutes | Signed Integer |
| 11:13 | DST Schedule (See Subsection 4.7.1.2) | N/A | N/A |
| 14 | DST Local Deployment Indicator (See Subsection 4.7.1.3) | N/A | 1 = yes |
| 15 | DST Regional Deployment Indicator (See Subsection 4.7.1.4) | N/A | 1 = yes |

4.7.1.1 Parameter – Local Time Zone UTC Offset

These bits constitute the higher order part of the word and provides static data on the local time zone (offset from UTC when DST not in effect, in minutes).

Data for the U.S. standard time zones are shown in Table 4-16. Time laws in the U.S. are the responsibility of the Department of Transportation (Reference [15]).

Table 4-16: Local Time Zone UTC Offset – U.S. Standard Time Zones

| Time Zone Name | Bits (0:10) | UTC Reference |
|--|-------------|--------------------|
| Atlantic | 11100010000 | (UTC –4 hours) |
| Eastern | 11011010100 | (UTC –5 hours) |
| Central | 11010011000 | (UTC –6 hours) |
| Mountain | 11001011100 | (UTC –7 hours) |
| Pacific | 11000100000 | (UTC –8 hours) |
| Alaska | 10111100100 | (UTC –9 hours) |
| Hawaii-Aleutian | 10110101000 | (UTC –10 hours) |
| Samoa | 10101101100 | (UTC –11 hours) |
| Chamorro | 01001011000 | (UTC +10 hours) |
| <i>In addition, for Canada:</i> | | |
| Newfoundland | 11100101110 | (UTC –3 1/2 hours) |

4.7.1.2 Parameter – DST Schedule

These bits provide static data on the schedule of Daylight Saving Time (DST) used regionally (for example, nationally), regardless of whether or not DST is practiced locally.

Table 4-17 shows the values of the bits 11:13 based on the Daylight Saving Time Schedule.

The dates and times in Table 4-17 are shown for reference; refer to the proper governing organization for the latest information (References [19] and [20]).

Table 4-17: DST Schedule

| Bits 11:13 | Daylight Saving Time Schedule |
|------------|---|
| 000 | Daylight Saving Time not practiced in this nation (e.g., Japan, Central America) or Daylight Saving Time practiced on an irregular schedule (e.g., Israel, Palestine) |
| 001 | U.S./Canada Begins 2:00 AM on the second Sunday of March Ends 2:00 AM on the first Sunday of November Subject to change according to Reference [19] |
| 010 | European Union (EU): 01:00 UTC on last Sunday of March until 01:00 UTC on last Sunday of October. Subject to change according to Reference [20] |
| 011 - 111 | Reserved |

Other global practices for DST may be added to this table as HD Radio broadcasts and receivers are introduced into those nations. An overflow of this table may be continued in another, future, SIS Parameter Message type.

In the United States and Canada, broadcasters must use a field value of 001 year-round, regardless of whether or not their local community practices Daylight Saving Time.

4.7.1.3 Parameter – DST Local Deployment Indicator

This bit provides static data on whether or not DST is practiced locally; 1 if it is and 0 if it is not.

In the United States, bit 14 is set to 1 year-round, except in Hawaii, American Samoa, Guam, Puerto Rico, the Virgin Islands, and major portions of Indiana and Arizona. In Canada, bit 14 is set to 1 year-round, except in most of Saskatchewan and portions of other Provinces, including British Columbia and Quebec.

The Energy Policy Act of 2005 extended Daylight Saving Time in the U.S. beginning in 2007, though Congress retained the right to revert to the 1986 law should the change prove unpopular or if energy savings are not significant. Going from 2007 forward, Daylight Saving Time in the U.S. begins at 2:00 a.m. on the second Sunday of March and ends at 2:00 a.m. on the first Sunday of November. See Reference [16].

Concurrence would require the use of UTC local offset 11001011100 (UTC – 7 hours), DST Schedule 001, and DST Practice (Bit 14) 0, year-round, in order to make California broadcasters most compatible with those of neighboring communities (e.g., Yuma, AZ).

Information regarding DST in this AIDD is subject to change, according to Reference [19].

4.7.1.4 Parameter – DST Regional Deployment Indicator

This bit provides seasonal data as to whether or not DST is in effect regionally (for example, nationally); 1 if it is and 0 if it is not.

Simple receivers can use this bit exclusively (ignoring Bits 11:13) to determine when to set the display clock one hour forward. Receivers should honor this bit only if Bit 14 or user setup indicates that DST is practiced locally. However, since this datum is not guaranteed in real time (either by all broadcasters, or in a timely manner by broadcasters that do provide it), more upscale receiver designs may instead prefer to internally compute the period of DST using the static data provided in bits 11:13. This will provide a better consumer experience. However, all receivers should honor this bit in preference to any predetermined schedule indicated by Bits 11:13. National rules for DST change occasionally and the receiver firmware may not be up-to-date or appropriate for the nation in which the receiver is being used.

In the United States and Canada, this bit should be set to 1 when the nation as a whole is practicing Daylight Saving Time (that is, in the summer), regardless of whether or not it is being practiced locally.

4.7.2 Broadcast Equipment Software Version Information

Message indices 4 through 12 may be utilized to broadcast software version information. Such information may be useful for tracking the evolution of the system and understanding field operation conditions. Such information may also be useful in aiding receivers to identify stations that support new features as the system evolves.

Message index 5 identifies the Exciter Core Software Version Number. The Core Software Version Number is independent of the specific equipment manufacturer.

Message index 4 provides a two-character Manufacturer ID identifying the specific equipment manufacturer.

Message index 6 provides the manufacturer-assigned version number for the Exciter.

If the broadcast system includes an Importer, the Importer Connected Bit (ICB) shall be set to “1” and message indices 8 through 12 shall be broadcast to convey the Importer software information. If the broadcast system does not include an Importer, the ICB shall be “0” and message indices 8 through 12 shall be omitted.

4.8 Universal Short Station Name / Station Slogan (MSG ID 1000)

This message type conveys either the Universal Short Station Name or the Station Slogan, depending on the state of the Name Type bit embedded in the message structure. Subsection 4.8.1 provides the details for the Universal Short Station Name; Subsection 4.8.2 provides the details for the Station Slogan.

Refer to Figure 4-24 for an illustration of the general message structure for this message type and Table 4-18 for a description of the fields in this common message structure.

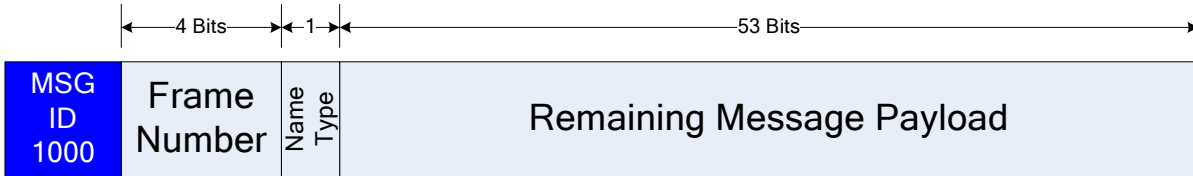

Figure 4-24: General Message Structure for MSG ID 1000

Table 4-18: Description of Fields within the Common Message Structure for MSG ID 1000

| Field Name | Range | Description |
|--------------|---|--|
| Name Type | 0 - 1 | Type = 0 indicates that the message type is Universal Short Station Name Type = 1 indicates that the message type is Station Slogan |
| Frame Number | If Name Type = 0, Range = 0 - 1 If Name Type = 1, Range = 0 - 15 | Indicates the current frame number of the message. Always zero for single-frame messages. |

4.8.1 Universal Short Station Name

The Universal Short Station Name provides additional capabilities beyond the standard Short Station Name (MSG ID 0001) message type. The Universal Short Station Name may be up to 12 characters in length, as shown in Figure 4-25. In addition, it supports international character sets.

The Universal Short Station Name cannot be broadcast in the SIS concurrently with a standard Short Station Name. If the standard Short Station Name is sufficient, it is recommended that it be used exclusively, due to its higher efficiency. However, for applications requiring more than four characters in the station name, such as weather/FEMA stations (760 associated stations) or Low Power FM (LPM) stations which use five or six alphanumeric characters, the Universal Short Station Name must be used. Also, for countries outside the U.S., the Universal Short Station Name may be required if the standard Short Station Name character set is insufficient and/or the station name is longer than four characters.

The Universal Short Station Name message structure is shown in Figure 4-25. The format allows for up to two frames of character data to be sent, which provides for 12 8-bit characters or six 16-bit characters. The format of the second frame is different from the first, as shown. Table 4-19 and Table 4-20 describe the data fields for the first and second frames, respectively.

**Universal Short Station Name
(Name Type = 0)**

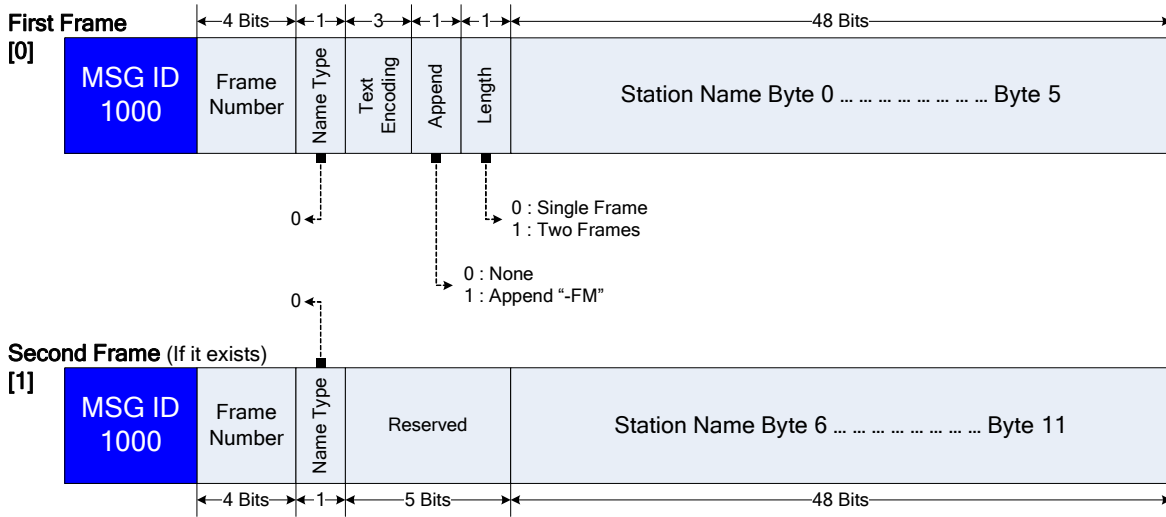

Figure 4-25: Universal Short Station Name – Message Structure

Table 4-19: Description of Universal Short Station Name Fields for Frame Number = 0

| Field Name | Range | Description |
|---------------|--------|--|
| Text Encoding | 0 to 7 | See Table 4-8 |
| Append | 0 to 1 | Append = 0: Receiver shall not append any information after the Station Name display Append = 1: Receiver shall append "-FM" after the Station Name display |
| Length | 0 to 1 | Length = 0: Station Name contained in a single frame Length = 1: Station Name contained in two frames |
| Station Name | N/A | For 8-bit character encoding, frame 0 contains six characters of the Station Name Byte 0 is the leftmost character For single-frame Station Names, any unused bytes to the right of the Station Name text are filled with NULL characters (0x00) For 16-bit character encoding, frame 0 contains three characters of the Station Name Bytes 0:1 convey the leftmost character For single-frame Station Names, any unused byte pairs to the right of the Station Name text are filled with NULL characters (0x00 00) |

Table 4-20: Description of Universal Short Station Name Fields for Frame Number = 1

| Field Name | Range | Description |
|--------------|-------|--|
| Station Name | N/A | <p>For 8-bit character encoding, frame 1 contains the remaining characters of the Station Name Byte 11 is the rightmost character Any unused bytes to the right of the Station Name text are filled with NULL characters (0x00)</p> <p>For 16-bit character encoding, frame 1 contains the remaining characters of the Station Name Bytes 10:11 convey the rightmost character Any unused byte pairs to the right of the Station Name text are filled with NULL characters (0x00 00)</p> |

4.8.2 Station Slogan

The Station Slogan message structure is shown in Figure 4-26. The format allows for up to 16 frames of character data to be sent, which accommodates up to 95 8-bit characters or 47 16-bit characters. The format of the first Station Slogan frame is different from the others, as shown. Table 4-21 and Table 4-22 describe the data fields for the first and subsequent frames, respectively.

When the Station Slogan is broadcast in conjunction with the Long Station Name (MSG ID 0010), both messages must have same content.

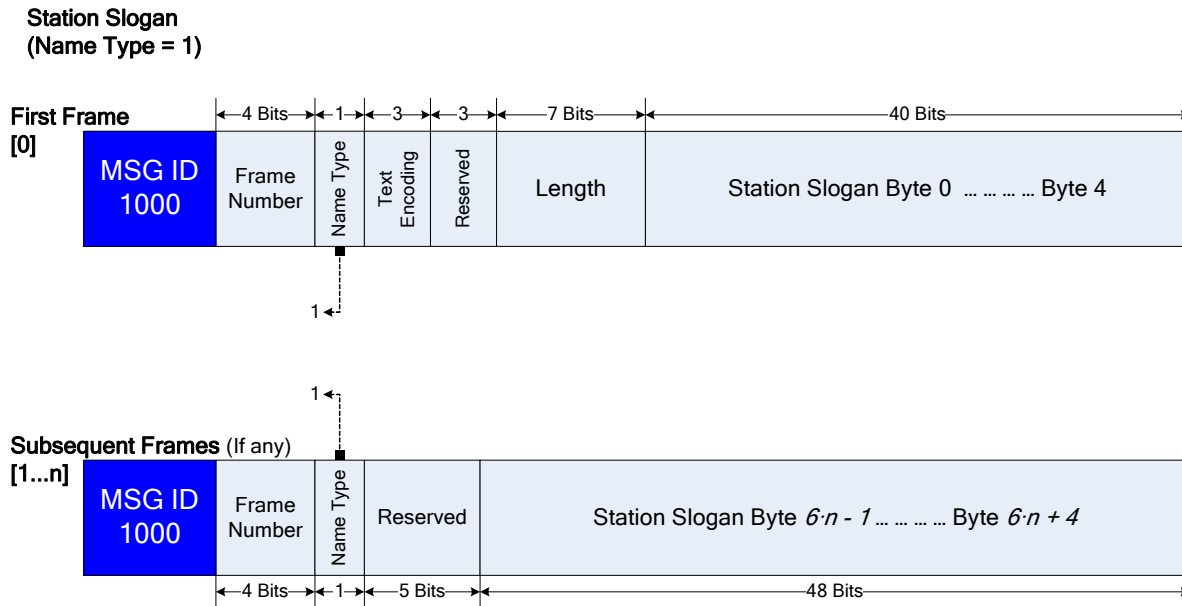

Figure 4-26: Station Slogan – Message Structure

Table 4-21: Description of Station Slogan Fields for Frame Number = 0

| Field Name | Range | Description |
|----------------|---|---|
| Text Encoding | 0 to 7 | See Table 4-8 |
| Length | 5 to 95, 8-bit encoding 4 to 94, 16-bit encoding | Defines the total number of bytes of the Station Slogan text, excluding any unused bytes in the last frame For 16-bit character encoding, the Length must be even. |
| Station Slogan | N/A | For 8-bit character encoding, frame 0 contains the first 5 characters of the Station Slogan Byte 0 is the leftmost character For single-frame Station Slogans, any unused bytes to the right of the Station Slogan text are filled with NULL characters (0x00) For 16-bit character encoding, frame 0 contains the first two characters of the Station Slogan Bytes 0:1 convey the leftmost character Byte 4 is always set to zero (0x00) For single-frame Station Slogans, any unused byte pairs to the right of the Station Slogan text are filled with NULL characters (0x00 00) |

Table 4-22: Description of Station Slogan Fields for Frame Number = 1 to n

| Field Name | Range | Description |
|----------------|-------|---|
| Station Slogan | N/A | <p>For 8-bit character encoding, frames 1 to n contain the additional characters of the Station Slogan, where the lowest numbered byte within a frame is the leftmost for that frame For the last frame, any unused bytes to the right of the Station Slogan text are filled with NULL characters (0x00)</p> <p>For 16-bit character encoding, frames 1 to n contain the additional characters of the Station Slogan, where the lowest numbered byte-pair within a frame is the leftmost for that frame For the last frame, any unused byte pairs to the right of the Station Slogan text are filled with NULL characters (0x00 00)</p> |

4.9 Active Radio (AR) Message (MSG ID 1001)

This message type allows the station to send alert messages. The alert messages are primarily intended for emergency public alerting and address any cause that may be defined by CAP [31]. Examples include weather alerts, child abduction alerts (AMBER alerts), and HAZMAT alerts. The message allows for waking-up receivers and further intelligent handling of the information provided by the station. The AR Message has a total payload of 58 bits per frame. It can span from two (minimum) frames to 63 frames. Figure 4-27 shows the message structure for the Active Radio Message. The format of the first frame is different from the others, as shown.

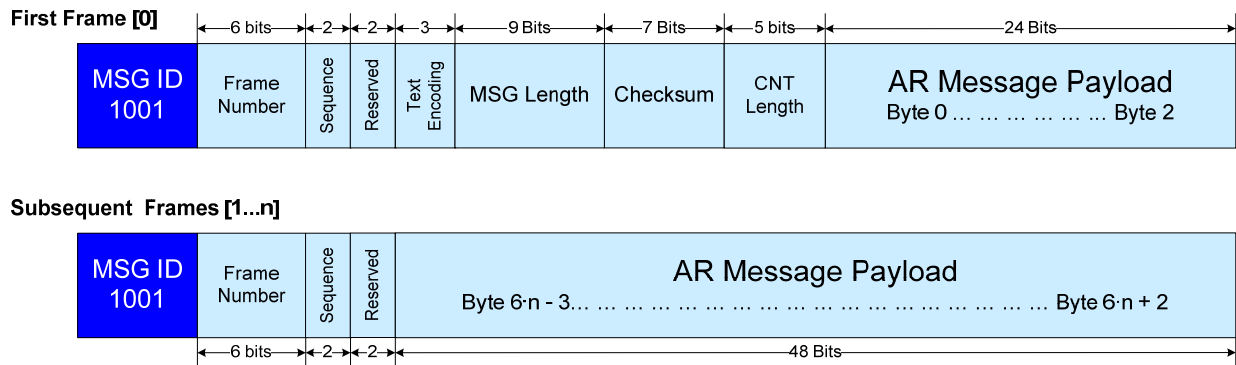

Figure 4-27: Active Radio Message – Message Structure

The AR Message can be used to send a string of up to 381 bytes per message which may include various bit-oriented data elements as well as 8-bit characters [22] or 16-bit characters [23]. A message may span up to 64 frames. Each message contains a sequence number indicating when the message content has changed. Any change in the message content is considered a new message and the sequence number is incremented. Length information and a 7-bit checksum are included in the first frame to increase receive reliability.

Table 4-23 and Table 4-24 describe the data fields for the first and subsequent frames, respectively.

Table 4-23: Description of AR Message Fields for Frame Number = 0

| Field Name | Range | Description |
|---------------|----------|---|
| Frame Number | 0 to 63 | Indicates the current frame number of the message Set to zero for the first frame |
| Sequence | 0 to 3 | Increments by 1, modulo 4, whenever the AR message content changes A new sequence number must commence with Frame 0 and the same number shall be used for all frames of a given AR Message |
| Reserved | 0 to 3 | Reserved for future use |
| Text Encoding | 0 to 7 | See Table 4-25 |
| MSG Length | 7 to 381 | Defines the total number of bytes of the AR Message payload, excluding any unused bytes in the last frame |
| Checksum | 0 to 127 | Checksum of all the bytes of the AR Message payload, as indicated by 'MSG Length' Refer to [32] for details |
| CNT Length | 3 to 31 | Defines the total number of byte-pairs of the control (CNT) data included in the AR Message payload Refer to [32] for details |

| Field Name | Range | Description |
|--------------------|-------|--|
| AR Message Payload | N/A | Frame 0 contains the first three bytes of the AR Message Payload. Byte 0 is the leftmost byte These three bytes contain control data and do not contain any text. Refer to [32] for details |

Table 4-24: Description of Station Message Fields for Frame Number = 1 to n

| Field Name | Range | Description |
|--------------------|---------|---|
| Frame Number | 1 to 63 | Indicates the current frame number of the message |
| Sequence | 0 to 3 | Increments by 1, modulo 4, whenever the AR message content changes A new sequence number must commence with Frame 0 and the same number shall be used for all frames of a given AR Message |
| Reserved | 0 to 7 | Reserved for future use |
| AR Message Payload | N/A | Frames 1 to 63 contain 4 to 380 bytes of the AR Message Payload. The count is from the leftmost byte. These bytes contain control data and may contain text when conveyed in the message. For the last frame, any unused bytes to the right of the AR Message payload are filled with NULL characters (0x00) Refer to [32] for details |

NRSC Supplemental Information provides the most up-to-date information regarding the Text Encoding Definitions: http://www.ibiquity.com/broadcasters/us_regulatory/nrsc_supplemental_information.

Table 4-25: Text Encoding Definitions – Active Radio

| Value | Service Type |
|---------------|---|
| 000 (default) | ISO/IEC 8859-1:1998 (Reference [22]) |
| 001 | ISO/IEC 8859-1:1998 compressed. Refer to [32] for details. |
| 010 and 011 | Reserved |
| 100 | ISO/IEC 10646-1:2000 UCS-2 (Little Endian) (Reference [23]) |
| 101 to 111 | Reserved |

4.9.1 AR Message Schedule Requirements

Regularly, scheduling SIS PDU messages may be configured by a broadcaster, based on various considerations; or otherwise it may use the default scheduling as further indicated in this document.

However, when broadcasting AR messages for the purpose of emergency public alerting, it is necessary to guarantee that broadcasting a message is completed within a specific time. This is expected by receivers, which are monitoring for alert messages, while also attempting to minimize their power consumption, whether in standby (ready to wake-up) or turned 'On'.

In order to avoid inadvertent scheduling when broadcasting alert messages and to provide adequate user experience, fixed (non-configurable) scheduling for SIS PDU messages is employed when broadcasting an AR Message. For details refer to Section 5.2.

4.10 CRC Field

Each PDU is terminated with a 12-bit Cyclic Redundancy Check (CRC) for the purpose of aiding the receiver in detecting transmission errors. The CRC, ordered as PDU bits 79:68, is computed as follows:

1. Fill PDU bits 79:68 with zeros.
2. Perform modulo-two division of PDU bits 79:0 by the generator polynomial $g(x)$,
Where $g(x) = X^{12} + X^{11} + X^3 + X + 1$
and PDU bit 79 is computed first.
3. The 12-bit remainder is then copied back into PDU bits 68:79, where bit 68 is considered the most significant remainder bit and bit 79 is the least significant remainder bit.

5 Applications and Examples

5.1 Station Location Example

As an example of how the position information is constructed, consider a location at N 39° 11' 46.32", W 76° 49' 6.59", and an altitude of 90.7 meters. The first step is to convert latitude and longitude to decimal degrees:

$$\text{Latitude} = 39 + \frac{11}{60} + \frac{46.32}{3600} = 39.1962 \text{ deg}$$

$$\text{Longitude} = 76 + \frac{49}{60} + \frac{6.59}{3600} = 76.8185 \text{ deg}$$

The next step is to convert all three parameters to the proper fractional format:

Latitude: $39.1962^\circ \cdot 8192 = 321095$ rounded to the nearest integer, = 0x04E647

Longitude: $76.8185^\circ \cdot 8192 = 629297$ rounded to the nearest integer, = 0x099A31, however, it is necessary to take the two's complement of this number to get West longitude = 0x3665CF

Altitude = ROUND (90.7/16) = 6 = 0x06

Finally, the parameters are packed into the appropriate message format:

High portion = 0x44E6470

Low portion = 0x3665CF6

It must be noted that frequency translator stations must exercise care in the use of the station ID number, station name, and station location. If the translator station acts as a repeater, then it will convey the station information of the primary station, not the translator station. It may be necessary for the translator station to produce its own station information to ensure proper operation of the system.

5.2 Scheduling of SIS PDUs on the PIDS Logical Channel

PDU scheduling on a block basis is provided for various cases.

5.2.1 Regular Scheduling

The regular scheduling applies to all the cases when an AR Message is not employed.

The FM system broadcasts 16 PIDS blocks per L1 frame while the AM system broadcasts only eight PIDS blocks per L1 frame. However, the HD Radio broadcasting system allows for scheduling a cycle of 16 PIDS blocks for both FM and AM systems.

While it is obvious that stations would like to broadcast their call sign, it may also be complemented by the Station ID (including FCC ID) and its location. It is also assumed that stations may want to broadcast a slogan or a short message. In order to attract listeners, as well as to allow for scanning for specific services, it is expected that stations would like to 'post' information regarding the services they provide. While there are several ways to schedule all of the conveyable information, Table 5-1 provides an example for one form of an optimized schedule for the FM system. The example shows the content versus speed tradeoff that allows for the broadcast of all of the desired information while still supporting the receiver's fast-scanning for services and thus allowing for an adequate listener experience. For details on how this schedule may be utilized for TPEG Traffic Services, refer to [33].

In the example, only one PIDS block is allocated for sending SIS Parameter Messages. Since this information is not time-critical, the broadcast system should cycle through each message, one at a time, whenever a SIS Parameter Message is scheduled. Since there are a total of 12 SIS Parameter Messages defined, a cycle will require 12 L1 frames (equivalent to approximately 18 seconds).

Similarly, Table 5-2 provides an example for PDU scheduling for the AM system. The schedule allows for the more frequent and periodic broadcast of Station Name; thus, the schedule allows for faster acquisition or search. On the other hand, the expected number of provided services is relatively limited and this requires less frequent broadcast of service information.

Table 5-1: Example Scheduling of SIS PDU Messages for the FM System

| Block | Payload 1 | Payload 2 |
|-------|-------------------------|-------------------------|
| 0 | SHORT STATION NAME | STATION ID |
| 1 | SERVICE INFO MESSAGE #1 | SERVICE INFO MESSAGE #2 |
| 2 | SHORT STATION NAME | STATION ID |
| 3 | STATION SLOGAN | |
| 4 | SHORT STATION NAME | STATION ID |
| 5 | SERVICE INFO MESSAGE #3 | SERVICE INFO MESSAGE #4 |
| 6 | SHORT STATION NAME | STATION ID |
| 7 | STATION LOCATION | STATION LOCATION |
| 8 | STATION MESSAGE | |
| 9 | SHORT STATION NAME | STATION ID |
| 10 | SERVICE INFO MESSAGE #5 | SERVICE INFO MESSAGE #6 |
| 11 | STATION SLOGAN | |
| 12 | SIS PARAMETER MESSAGE | STATION ID |
| 13 | STATION MESSAGE | |
| 14 | SHORT STATION NAME | STATION ID |
| 15 | SERVICE INFO MESSAGE #7 | SERVICE INFO MESSAGE #8 |

Table 5-2: Example Scheduling of SIS PDU Messages for the AM System

| Block | Payload 1 | Payload 2 |
|-------|-------------------------|--------------------|
| 0 | SHORT STATION NAME | STATION ID |
| 1 | STATION MESSAGE | |
| 2 | SERVICE INFO MESSAGE #1 | SHORT STATION NAME |
| 3 | SIS PARAMETER MESSAGE | STATION LOCATION |
| 4 | SHORT STATION NAME | STATION ID |
| 5 | STATION SLOGAN | |
| 6 | SERVICE INFO MESSAGE #2 | SHORT STATION NAME |
| 7 | STATION MESSAGE | |

5.2.2 Emergency Alert Schedule

When the station broadcasts an Active Radio message for conveying an Emergency Public Alert, the objective is to broadcast the message as fast as practical. Therefore, the PDU schedule is fixed (not station configurable), as shown in Table 5-3 for FM and in Table 5-4 for AM. The AR message frame is broadcast over most of the PDUs while the remaining PDUs convey the station’s name and the station’s ID. The fixed schedule allows for the broadcast of a complete AR message in less than eight seconds in FM and in less than 16 seconds in AM.

Table 5-3: SIS PDU Schedule when AR Message is employed for Emergency Public Alert – FM Schedule

| Block | Payload 1 | Payload 2 |
|-------|--------------------|------------------|
| 0 | Short Station Name | Station ID |
| 1 | AR Message | |
| 2 | AR Message | |
| 3 | AR Message | |
| 4 | Short Station Name | Station Location |
| 5 | AR Message | |
| 6 | AR Message | |
| 7 | AR Message | |
| 8 | Short Station Name | Station ID |
| 9 | AR Message | |
| 10 | AR Message | |
| 11 | AR Message | |
| 12 | Short Station Name | Station Location |
| 13 | AR Message | |
| 14 | AR Message | |
| 15 | AR Message | |

Table 5-4: SIS PDU Schedule when AR Message is employed for Emergency Public Alert – AM Schedule

| Block | Payload 1 | Payload 2 |
|-------|--------------------|------------------|
| 0 | Short Station Name | Station ID |
| 1 | AR Message | |
| 2 | AR Message | |
| 3 | AR Message | |
| 4 | Short Station Name | Station Location |
| 5 | AR Message | |
| 6 | AR Message | |
| 7 | AR Message | |

5.3 Advanced Absolute L1 Frame Number Processing

The SIS Transport allocates two bits to broadcast the absolute L1 frame number in a serial fashion. The format is different for AM and FM as outlined in the following two subsections. In both cases, the value of ALFN to be transmitted over the PIDS channel is updated coincident with L1 block 0 of each L1 frame.

5.3.1 FM System Processing

The 16 LSBs, labeled d16 through d31 in Figure 5-1, are transmitted as 2-bit pairs mapped into the ADV ALFN field of each PIDS block starting with block 0. ALFN bits d30:31 are broadcast at block 0 of each frame, ALFN bits d28:29 are broadcast at block 1 of each frame, and ALFN bits d16:17 are broadcast at block 7 of each frame.

ALFN bits d0:15 are further subdivided into pairs and mapped to the ADV ALFN field in blocks 8 through 15 as shown in Figure 5-1.

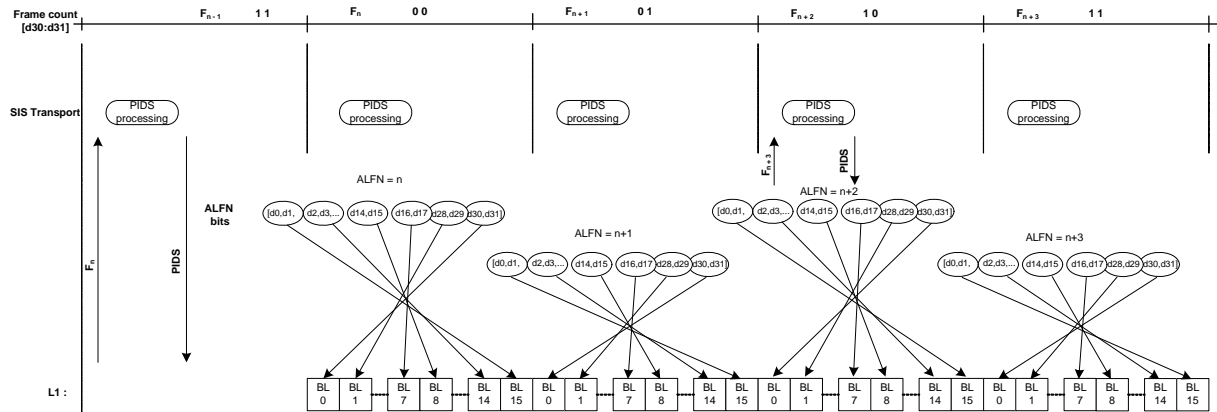

Figure 5-1: Broadcasting ALFN over the HD Radio FM System

5.3.2 AM System Processing

The 32 bits are subdivided into 16 bits numbered d16 through d31 (16 LSBs) and 16 bits indexed d0 through d15 (16 MSBs), as shown in Figure 5-2. ALFN bits d16:31 are subdivided into pairs and mapped to the two-bit ADV ALFN field of each PIDS block starting with block 0. ALFN bits d30:31 are broadcast at block 0 of each frame, ALFN bits d28:29 are broadcast at block 1 of each frame and ALFN bits d16:17 are broadcast at block 7 of the frame. This process takes place when ALFN d30:31 are not equal to 00.

ALFN bits d0:15 are subdivided into pairs and mapped to the ADV ALFN field in blocks 0 through 7 as shown. This occurs once with every four frames and is indicated when ALFN d30:31 are equal to 00.

The 16 LSBs of the ALFN are broadcast in three out of every four PIDS blocks; the 16 MSBs are broadcast once every four PIDS blocks.

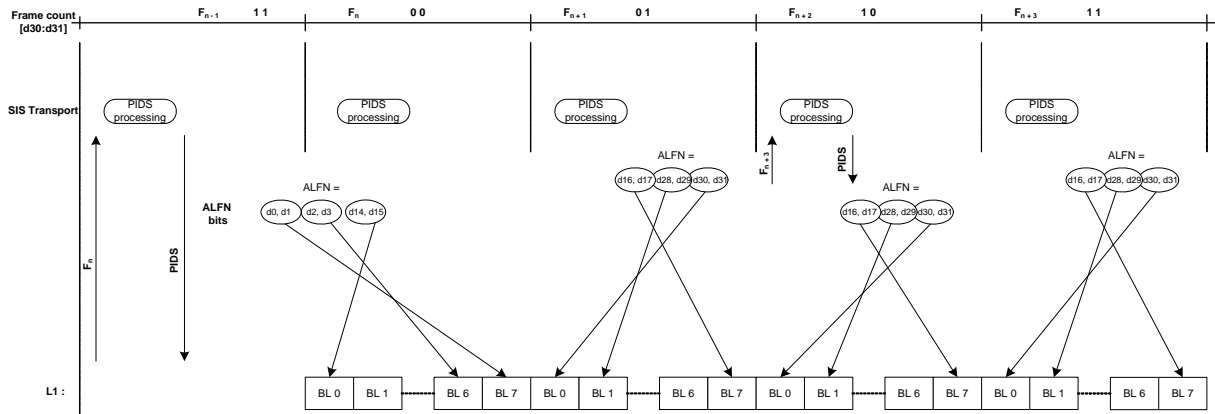

Figure 5-2: Broadcasting ALFN over the HD Radio AM System

5.3.3 Handling of Absolute L1 Frame Number in Layer 1

L1 does not handle ALFN directly, in regards to broadcasting the frame number. The frame number is conveyed over the PIDS logical channel in Layer 1 as part of a SIS message.

In all AM and FM service modes, the relevant portion of the ALFN being sent applies to the actual frame number at the time it is broadcast. Thus, Layer 1 must ensure proper synchronization of the ALFN being sent relative to absolute GPS time.

5.4 Clock Support

The SIS Transport allows for data to be broadcast making display clocks associated with receivers easier for consumers to use. The provision of these data by a broadcaster is optional if the ALFN is locked to GPS time (Bit 65 of the SIS PDU set to one), and forbidden if it is not (Bit 65 of the SIS PDU set to zero). If present at all, these data may be sent approximately once per minute, or otherwise at the convenience of the broadcaster. Receivers may utilize these data as best suits their design goals.

5.4.1 Handling Leap Seconds

The time standard for clocks around the world is UTC (Coordinated Universal Time). To keep UTC synchronized to astronomical time (defined by the earth's rotation), it is occasionally adjusted by a second. The adjustments average about once a year (so far) and occur as leap seconds, meaning all UTC clocks observe a 61 second minute at midnight when the adjustment occurs. The standard practice is to make adjustments at midnight UTC either December 31 or June 30.

As explained in Subsection 4.3, bit 65 of a PDU must be set to one for the ALFN to be locked to GPS time and for the time of day calculation to be accurate.

HD Radio transmissions may be synchronized to GPS time, which does not have any leap second adjustments. This means that GPS runs ahead of UTC and the receiver derives UTC time as follows:

$$\text{Time(UTC)} = \text{Time(GPS)} - \text{Leap Seconds}$$

$$\text{Time(UTC)} = (65536 / 44100) \cdot \text{ALFN} - \text{Leap Seconds}$$

Since 1980, 14 leap seconds have been added to UTC, so GPS is now running 14 seconds ahead of UTC. Leap second adjustments may occur periodically; if they occur, they will occur on June 30 or December 31. See Reference [21] for the latest information.

A SIS message is used to convey the current leap second correction factor.

The parameters that are needed to continuously account for leap seconds in the calculation of UTC from the ALFN are:

- the current time offset (GPS time – UTC time),
- ALFN representing the GPS time of a pending leap second adjustment,
- the new time offset after the adjustment.

These parameters are sent over the SIS and should be saved in persistent storage by the receiver so that accurate UTC time can be computed when necessary.

To ensure smooth operation during leap second adjustments, it is suggested that the broadcast system announce leap second adjustments several months in advance. In addition, pending leap second adjustments should continue to be broadcast for at least several hours after the adjustment event has occurred.

Note that the current number of leap seconds as well as the exact time of a pending leap-second adjustment is sent by the GPS satellite constellation as part of the GPS broadcast navigation message. Most GPS-locked time references provide this information and can be used for the HD Radio system.

5.4.2 Handling Local Time

Local time differs from UTC, owing to both the local time zone and the local practice with respect to observing some form of Daylight Saving Time (DST). SIS Parameter Message Index 3 provides digital data on these local customs, so that a receiver's digital display clock can automatically match the local time as spoken in main program audio.

These data describe the local custom at the location of the broadcaster, which may or may not be the same as the local custom at the place of the receiver. Near time-zone boundaries, consumers can receive a multiplicity of stations providing different data. Therefore, these data are provided only as *hints*, the interpretation and utilization of which should be made discretionary, subject to customer control. Receivers may use these data as initial guesses (for example, at initial installation) as to what a persistent configuration should be, with the expectation that consumers may manually adjust the initial guess. (Most of the time, no manual adjustment would be necessary.) Mobile receivers may have a design option to update their clocks with different, localized data as they travel across the country. Or receivers may ignore these data entirely.

AM broadcasters may refrain from transmitting, and AM receivers may refrain from interpreting, these data during evening and nighttime hours.